

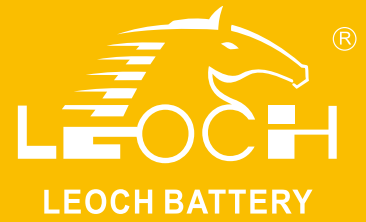

LP Series-General Purpose LP12-250(12V250Ah)



Specifications

Rated Voltage	12V	
Nominal Capacity	250.0Ah	(C ₁₀ , 1.80V/cell)
Dimension	Length	522±2mm (20.55 inches)
	Width	268±2mm (10.55 inches)
	Container Height	220±2mm (8.66 inches)
	Total Height	226±2mm (8.90 inches)
Approx Weight	70.6 Kg (155.7 lbs)	
Terminal	M8	
Container Material	ABS	
Rated Capacity (25°C)	262.0 Ah	(20hr, 13.1A, 1.80V/cell)
	250.0 Ah	(10hr, 25.0A, 1.80V/cell)
	227.5 Ah	(5hr, 45.5A, 1.75V/cell)
	207.3 Ah	(3hr, 69.1A, 1.75V/cell)
	159.4 Ah	(1hr, 159.4A, 1.60V/cell)
Max. Discharge Current	2500A (5s)	
Internal Resistance (25°C)	Approx 2.8mΩ	
Operating Temp. Range	Discharge	-15 ~ 50°C (5 ~ 122°F)
	Charge	-20 ~ 40°C (-4 ~ 104°F)
	Storage	-15 ~ 40°C (5 ~ 104°F)
Nominal Operating Temp. Range	25±3°C (77±5°F)	
Cycle Use	Initial Charging Current less than 75.0A. Voltage 14.4V~15.0V at 25°C(77°F)Temp. Coefficient -30mV/°C	
Standby Use	Initial Charging Current less than 75.0A. Voltage 13.5V~13.8V at 25°C(77°F)Temp. Coefficient -20mV/°C	
Effect of temp. to Capacity	40°C (104°F)	103%
	25°C (77°F)	100%
	0°C (32°F)	86%
Self Discharge	LP series batteries may be stored for up to 6 months at 25°C(77°F) and then a freshening charge is required. For higher temperatures the time interval will be shorter.	



Layout

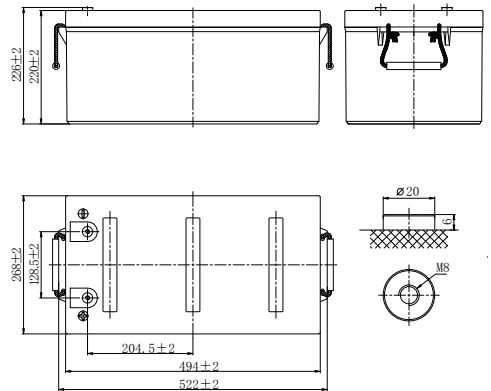

Constant Current Discharge (Amperes) at 25 °C (77°F)

F.V/Time	10min	15min	20min	30min	45min	1h	1.5h	2h	3h	4h	5h	6h	8h	10h	20h
1.85V/cell	362.5	320.7	252.2	225.5	164.9	139.7	101.2	85.1	62.4	49.0	42.5	37.5	28.8	23.9	12.7
1.80V/cell	411.4	363.4	285.1	245.5	174.7	144.7	104.7	87.9	67.8	52.3	44.7	40.3	30.3	25.0	13.1
1.75V/cell	446.2	393.4	307.8	250.5	181.0	151.8	110.0	92.5	69.1	53.3	45.5	40.6	30.5	25.3	13.3
1.70V/cell	475.7	417.8	326.4	255.5	184.6	154.8	112.2	94.4	70.4	54.2	46.3	40.8	30.9	25.5	13.4
1.67V/cell	490.8	430.0	335.3	259.3	187.3	157.1	113.9	95.7	71.1	55.0	47.2	41.0	31.4	25.8	13.6
1.60V/cell	507.6	443.4	343.9	263.0	190.1	159.4	115.5	97.1	71.7	55.7	47.9	41.3	31.8	26.1	13.7

Constant Power Discharge (Watts/cell) at 25 °C (77°F)

F.V/Time	10min	15min	20min	30min	45min	1h	1.5h	2h	3h	4h	5h	6h	8h	10h	20h
1.85V/cell	641.2	582.9	460.5	413.7	304.4	259.3	188.4	158.9	117.1	92.3	80.4	71.1	54.9	45.6	24.2
1.80V/cell	717.3	652.0	515.0	446.8	320.3	267.2	193.9	163.3	126.5	98.1	84.2	76.0	57.6	47.6	25.1
1.75V/cell	765.6	695.9	549.7	452.4	329.9	279.1	202.9	171.2	128.6	99.6	85.3	76.4	57.7	48.1	25.2
1.70V/cell	804.8	731.5	577.9	457.6	334.2	283.1	206.0	174.0	130.7	101.0	86.5	76.7	58.6	48.5	25.5
1.67V/cell	817.9	743.4	587.3	460.9	337.2	285.7	208.0	175.7	131.3	102.1	88.0	76.8	59.2	49.1	25.8
1.60V/cell	829.4	753.9	595.6	462.8	338.9	287.8	209.7	177.1	131.8	102.9	88.9	77.1	59.9	49.5	26.0



LP Series-General Purpose LP12-250(12V250Ah)

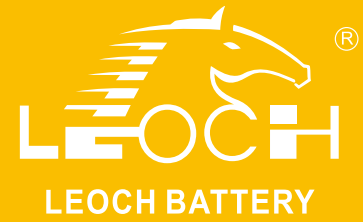

Applications

- All purpose
- Uninterruptable Power Supply (UPS)
- Electric Power System (EPS)
- Emergency backup power supply
- Alarm and security system
- Communication power supply
- DC power supply
- Auto control system

General Features

- 8 years design life(25°C)
- Special exhaust structure and sealing technology, safe and reliable, flexible installation, convenient maintenance
- PbCaSn alloy for plate grids: less gassing, less self-discharging
- High quality AGM separator: extend cycle life and prevent micro short circuit
- High purity raw material: ensure low self discharge rate

Standards

- Compliance with IEC 60896 standards, EU Battery Directive
- UL, CE Certified
- Manufactured in Leoch®IATF 16949, ISO45001, ISO 9001 and ISO 14001 certified production facilities

Discharge Characteristics

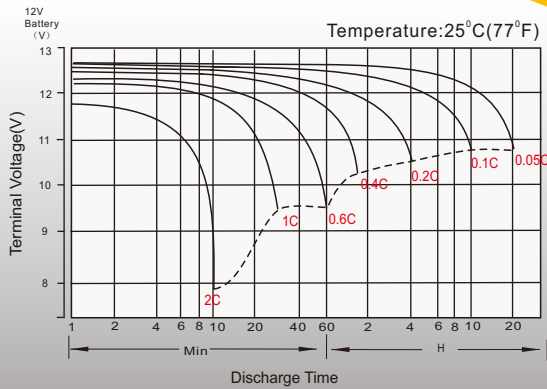

Float Charging Characteristics

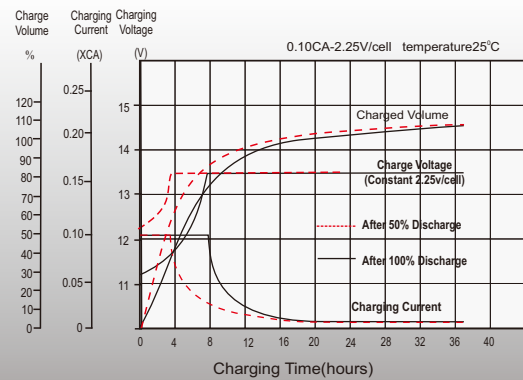

Temperature Effects in Relation to Battery Capacity

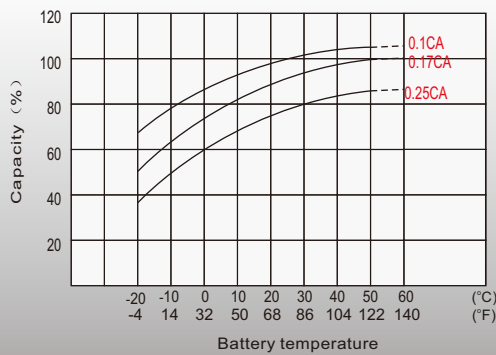

Float Service Life

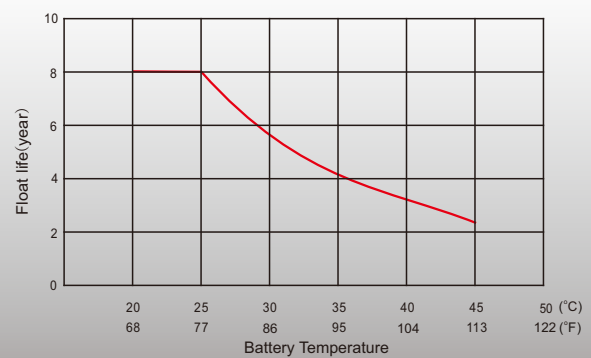

Sales Offices Worldwide

China Sales Office

5th Floor, Xinbaohui Bldg., Nanhai Blvd.,
Nanshan, Shenzhen, China. 518052
Tel: +86-755-86036060 (100 lines)
Tel: +86-755-26067269
E-mail: export@leoch.com

HongKong Sales Office

Workshop C, 33/F, TML Tower, No. 3 Hoi Shing Road,
Tsuen Wan, New Territories, Hong Kong
Tel: +852 35786666
Tel: +44(0) 1452 729428 / 1452 729696
E-mail: sales.hk@leoch.com

Singapore Sales Office

No. 1 Tech Park Crescent,
Singapore 638131
Tel: +65 68636078
Tel: +65 6863 6079
Email: sales.sg@Leoch.com

Australia Sales Office

2 /29 Tarlington Place, Smithfield, NSW 2164
Australia
Tel: 02 9756 0950
E-mail: sales.au@leoch.com

North America Sales Office

19751 Descartes
Foothill Ranch, CA 92610, USA
Tel: 949-588-5853
Tel: 949-588-5966
E-mail: sales@leoch.us
Http:// www.leoch.us

UK Sales Office

9B Wheatstone Court, Waterwells, Business Park,
Gloucester, GL2-2AQ, UK United Kingdom
Tel: +44(0) 1452 729428 / 1452 729696
Tel: +44 1452 690125
E-mail: Sales.Europe@leoch.com
Http:// www.leoch.eu

EMEA Sales Office

1 Deligiorgi St., 121 31 Athens,
Greece
Tel: +30 210 5760318 (2 lines)
Tel: +30 210 5760318 (2 lines)
E-mail: support_EMEA@leoch.com
Http:// www.leoch.eu

India Sales Office

Shed no.A-53(b), 2nd Stage of Peenya Industrial Area,
Bangalore North Taluk, Bangalore-560058, India
Tel: +91-80-23440018/23440019
Tel: +91-80-23440017
E-mail: indiasales@leoch.com



[Http://www.leoch.com](http://www.leoch.com)

© 2020 LEOCH. All rights reserved.

Trademarks and logos are the property of LEOCH and its affiliates unless otherwise noted.
Subject to revisions without prior notice.

Publication No.: LB-LP12-250-PD-EN-V2.2-202104