

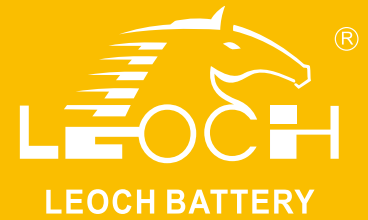

# LP Series-General Purpose LP12-12(12V12Ah)



## Specifications

Rated Voltage	12V	
Nominal Capacity	12.0Ah	(C <sub>20</sub> , 1.75V/cell)
Dimension	Length	151±2mm (5.95 inches)
	Width	98±1mm (3.86 inches)
	Container Height	95±1mm (3.74 inches)
	Total Height	101±2mm (3.98 inches)
Approx Weight	3.24 Kg (7.14 lbs)	
Terminal	T1/T2	
Container Material	ABS	
Rated Capacity (25°C)	12.0 Ah	(20hr, 0.600A, 1.75V/cell)
	11.2 Ah	(10hr, 1.12A, 1.75V/cell)
	10.2 Ah	(5hr, 2.04A, 1.75V/cell)
	9.00 Ah	(3hr, 3.00A, 1.75V/cell)
	7.20 Ah	(1hr, 7.20A, 1.60V/cell)
Max. Discharge Current	180A (5s)	
Internal Resistance (25°C)	Approx 19mΩ	
Operating Temp. Range	Discharge	-15 ~ 50°C (5 ~ 122°F)
	Charge	-20 ~ 40°C (-4 ~ 104°F)
	Storage	-15 ~ 40°C (5 ~ 104°F)
Nominal Operating Temp. Range	25±3°C (77±5°F)	
Cycle Use	Initial Charging Current less than 3.6A. Voltage 14.4V~15.0V at 25°C(77°F)Temp. Coefficient -30mV/°C	
	Standby Use	
Effect of temp. to Capacity	Initial Charging Current less than 3.6A. Voltage 13.5V~13.8V at 25°C(77°F)Temp. Coefficient -20mV/°C	
	40°C (104°F)	103%
	25°C (77°F)	100%
Self Discharge	0°C (32°F)	86%
	LP series batteries may be stored for up to 6 months at 25°C(77°F) and then a freshening charge is required. For higher temperatures the time interval will be shorter.	

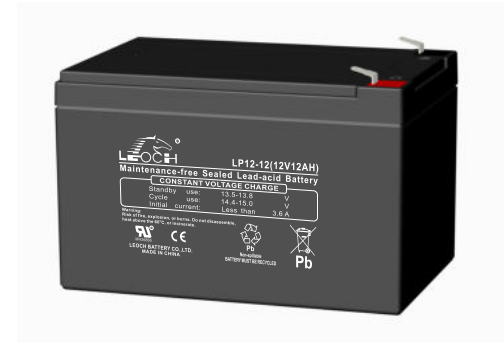

## Layout

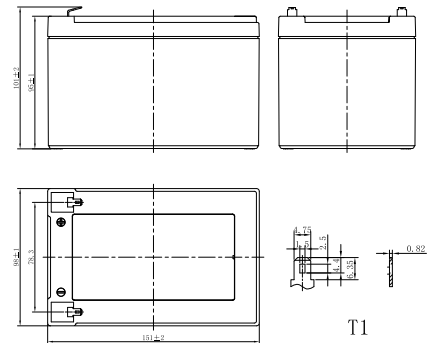

## Constant Current Discharge (Amperes) at 25 °C (77°F)

F.V/Time	5min	10min	15min	20min	30min	45min	1h	1.5h	2h	3h	4h	5h	6h	8h	10h	20h
1.85V/cell	30.6	22.7	18.1	14.8	11.0	8.07	6.59	4.81	3.82	2.91	2.34	1.99	1.70	1.34	1.09	0.587
1.80V/cell	33.2	23.9	18.8	15.2	11.3	8.23	6.72	4.90	3.88	2.95	2.37	2.01	1.72	1.35	1.10	0.594
1.75V/cell	35.9	25.1	19.5	15.7	11.5	8.39	6.84	4.98	3.94	3.00	2.40	2.04	1.74	1.37	1.12	0.600
1.70V/cell	38.6	26.2	20.2	16.2	11.8	8.55	6.96	5.06	4.01	3.04	2.43	2.07	1.77	1.39	1.13	0.606
1.67V/cell	40.2	26.9	20.6	16.4	12.0	8.65	7.03	5.11	4.04	3.07	2.45	2.08	1.78	1.40	1.14	0.609
1.60V/cell	43.7	28.6	21.6	17.1	12.3	8.88	7.20	5.22	4.12	3.13	2.50	2.12	1.81	1.42	1.16	0.618

## Constant Power Discharge (Watts/cell) at 25 °C (77°F)

F.V/Time	5min	10min	15min	20min	30min	45min	1h	1.5h	2h	3h	4h	5h	6h	8h	10h	20h
1.85V/cell	58.2	43.5	34.8	28.4	21.2	15.7	12.8	9.40	7.49	5.72	4.60	3.92	3.36	2.65	2.17	1.17
1.80V/cell	62.7	45.4	36.0	29.2	21.7	15.9	13.0	9.53	7.58	5.79	4.66	3.97	3.40	2.68	2.19	1.19
1.75V/cell	67.3	47.4	37.1	29.9	22.1	16.2	13.2	9.66	7.68	5.87	4.72	4.02	3.44	2.71	2.22	1.20
1.70V/cell	71.8	49.3	38.2	30.7	22.5	16.4	13.4	9.79	7.78	5.94	4.77	4.06	3.48	2.74	2.24	1.21
1.67V/cell	74.6	50.5	38.9	31.1	22.8	16.6	13.5	9.87	7.84	5.98	4.80	4.09	3.50	2.76	2.26	1.22
1.60V/cell	80.4	53.1	40.4	32.1	23.3	16.9	13.8	10.0	7.97	6.08	4.88	4.15	3.56	2.80	2.29	1.24



# LP Series-General Purpose LP12-12(12V12Ah)

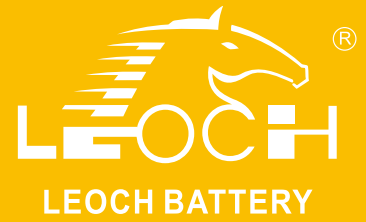

## Applications

- All purpose
- Uninterruptable Power Supply (UPS)
- Electric Power System (EPS)
- Emergency backup power supply
- Alarm and security system
- Communication power supply
- DC power supply
- Auto control system

## General Features

- 5 years design life(25°C)
- Special exhaust structure and sealing technology, safe and reliable, flexible installation, convenient maintenance
- PbCaSn alloy for plate grids: less gassing, less self-discharging
- High quality AGM separator: extend cycle life and prevent micro short circuit
- High purity raw material: ensure low self discharge rate

## Standards

- Compliance with IEC 60896 standards, EU Battery Directive
- UL, CE Certified
- Manufactured in Leoch®IATF 16949, ISO45001, ISO 9001 and ISO 14001 certified production facilities

## Discharge Characteristics

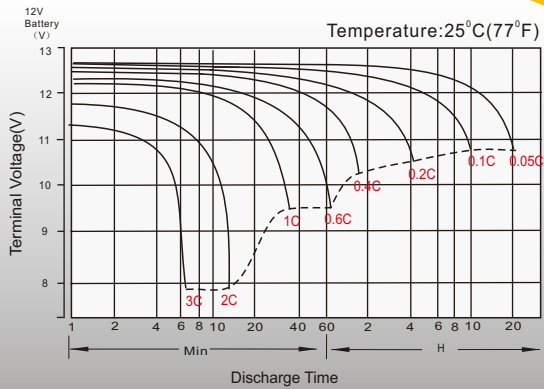

## Float Charging Characteristics

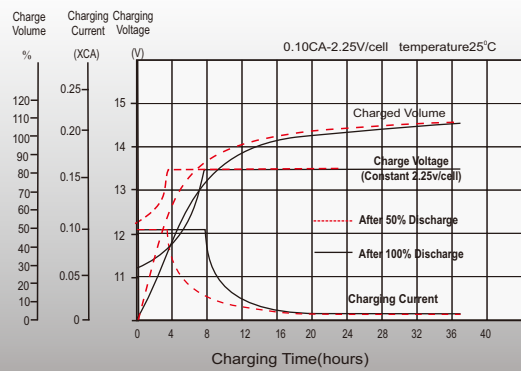

## Temperature Effects in Relation to Battery Capacity

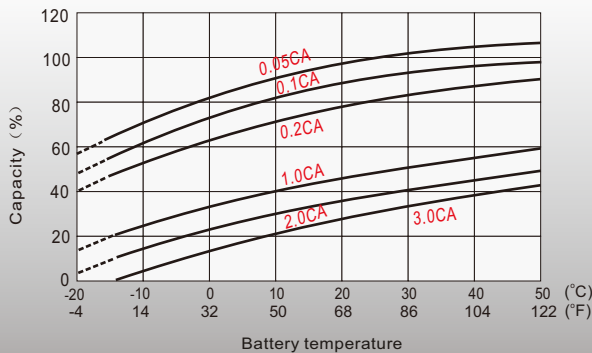

## Float Service Life

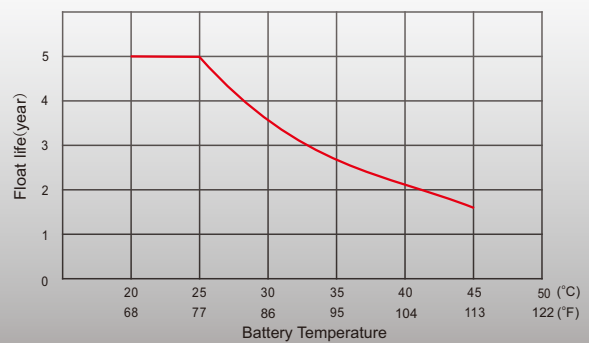

## Sales Offices Worldwide

### China Sales Office

5th Floor, Xinbaohui Bldg., Nanhai Blvd.,  
Nanshan, Shenzhen, China. 518052  
Tel: +86-755-86036060 (100 lines)  
Tel: +86-755-26067269  
Fax: +86-755-26067269  
E-mail: export@leoch.com

### HongKong Sales Office

Workshop C, 33/F, TML Tower, No. 3 Hoi Shing Road,  
Tsuen Wan, New Territories, Hong Kong  
Tel: +852 35786666  
Tel: +44(0) 1452 729428 / 1452 729696  
Fax: +44 1452 690125  
E-mail: sales.hk@leoch.com

### Singapore Sales Office

No. 1 Tech Park Crescent,  
Singapore 638131  
Tel: +65 68636078  
Tel: +65 6863 6079  
Fax: +65 6863 6079  
Email: sales.sg@Leoch.com

### Australia Sales Office

2 /29 Tarlington Place, Smithfield. NSW 2164  
Australia  
Tel: 02 9756 0950  
E-mail: sales.au@leoch.com

### North America Sales Office

19751 Descartes  
Foothill Ranch, CA 92610, USA  
Tel: 949-588-5853  
Tel: 949-588-5853  
Fax: 949-588-5966  
E-mail: sales@leoch.us  
Http://www.leoch.us

### UK Sales Office

9B Wheatstone Court. Waterwells, Business Park,  
Gloucester, GL2-2AQ, UK United Kingdom  
Tel: +44(0) 1452 729428 / 1452 729696  
Tel: +44 1452 690125  
Fax: +44 1452 690125  
E-mail: Sales.Europe@leoch.com  
Http://www.leoch.eu

### EMEA Sales Office

1 Deligiorgi St., 121 31 Athens,  
Greece  
Tel: +30 210 5760318 (2 lines)  
Tel: +30 210 5760318 (2 lines)  
E-mail: support\_EMEA@leoch.com  
Http://www.leoch.eu

### India Sales Office

Shed no.A-53(b), 2nd Stage of Peenya Industrial Area,  
Bangalore North Taluk, Bangalore-560058, India  
Tel: +91-80-23440018/23440019  
Tel: +91-80-23440017  
Tel: +91-80-23440017  
E-mail: indiasales@leoch.com



[Http://www.leoch.com](http://www.leoch.com)

© 2020 LEOCH. All rights reserved.

Trademarks and logos are the property of LEOCH and its affiliates unless otherwise noted.  
Subject to revisions without prior notice.

Publication No.: LB-LP12-12-PD-EN-V2.0-202004